

AUTOMATIC ELECTRIC GUN SERIES

AIR SPORT GUN



BOTH ELEPHANT

Emulational High-powered Nicety

Notice en français

1 Composants

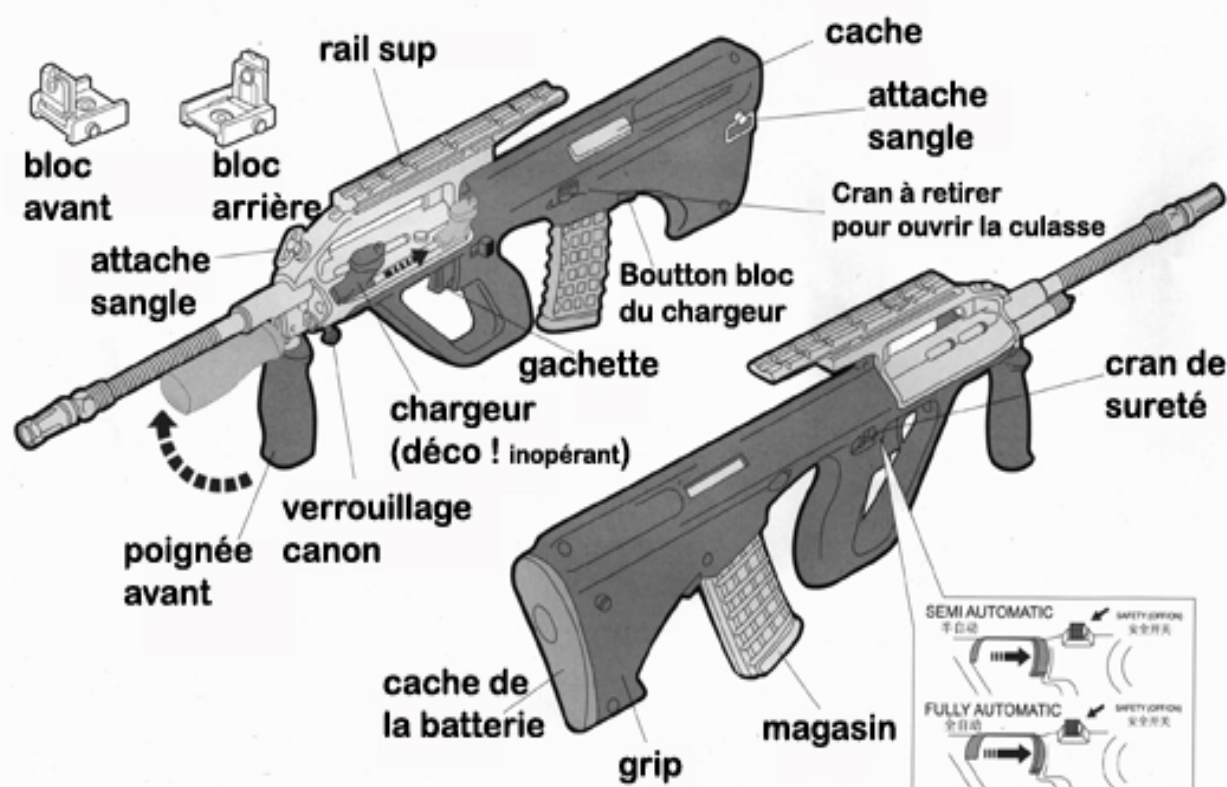

2 Chargement batterie

- 1 appuyez sur les côtés du cache retirez-le. Connectez la batterie à la fiche.



2 Connectez la batterie

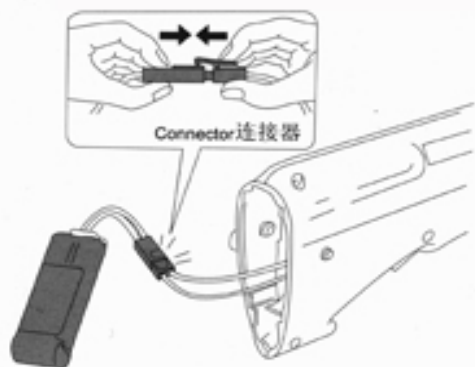

3 remplacez-la comme suit et refermez avec le cache

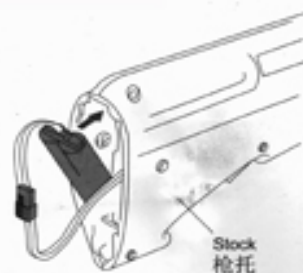

3 A l'aide du tournevis, vissez comme suit le rail avec les blocs avant et arrière

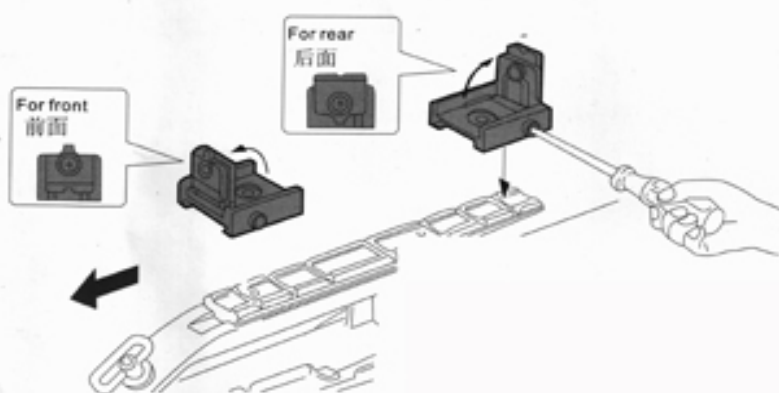

Bullets shift leftwards.
弹位向左



FRONT
前面

Bullets shift upwards.
弹位向上

Sight leaf 表尺板

Bullets shift rightwards.
弹位向右

Loosen
松开

Bullets shift downwards.
弹位向下

4 pose de la lunette : vissez-la tout simplement sur le rail

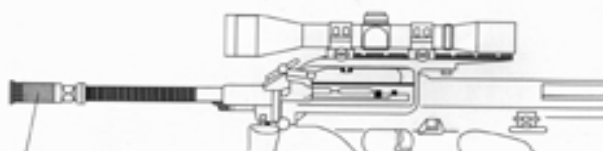

5 Chargeur :



retirez le chargeur en pressant le bouton (photo 1 p1)

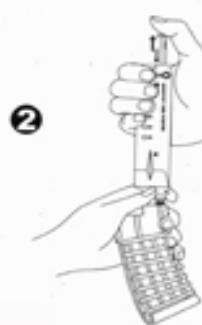

versez les billes

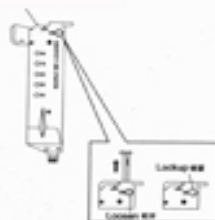

remplacez-le

appuyez sur le bouton de la chargette les billes entrent dans le chargeur

Recharge de la batterie : 4 heures.

Soyez présent et vigilant lors de la charge,
vous êtes responsable.

● Wear protective eye wear & face mask when playing AirSoft Sports.

certified starting safety goggles



● NEVER brandish or fire AirSoft Sport Gun at animal, or people beyond a certified and regulated AirSoft Sport arena. Brandishing a gun in public is against the law, serious consequences could arise



● Read and understand the operating and safety manual before using your AirSoft Sport Gun.

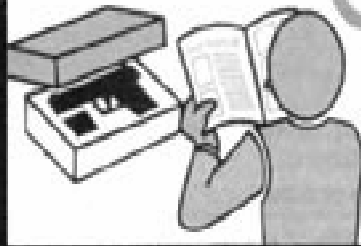

● Do not look directly into the gun barrel to avoid accidental discharge of BB.



● Be aware of your surroundings to avoid accidents.



● ALWAYS transport an AirSoft Sport Gun inside a locked carrying case. Make sure it's unloaded. Never carry your AirSoft Sport Gun in open view, as a concealed weapon, or brandish an AirSoft Sport Gun in public.

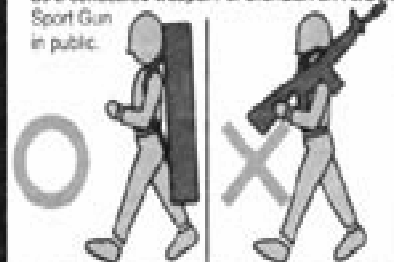

● Do not disassemble or modify your AirSoft Sport Gun, doing so will void all warranty. Service by authorized centers only. Removal of the orange safety barrel marking is a federal offense.



● Always install safety barrel plug when you are not using your AirSoft Sport Gun.

